

# GEBERIT INSTALLATION SYSTEMS

## Systems for Wall-Hung Toilets for Sigma 2x6 Installation

### Geberit Duofix Carrier, Sigma 2x6 Installation

Model No.	Description	List Price \$
111.335.00.5	Carrier frame with 1.60/0.8 GPF Sigma Concealed Tank	622.00
111.902.00.5	Carrier frame with 1.28/0.8 GPF Sigma Concealed Tank	622.00

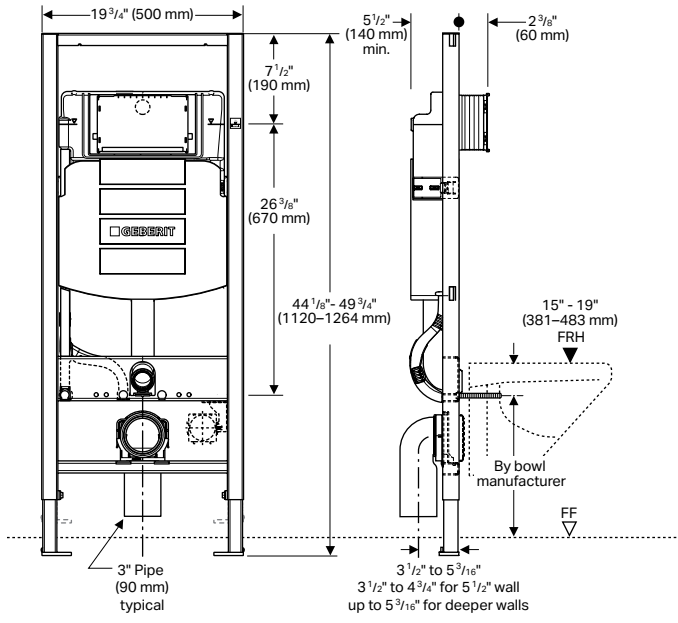



**NOTES:**





1. Concealed tank shipped dual-flush ready
2. Geberit Duofix Carrier for 2-hole washdown style wall-hung toilet fixtures only
3. Refer to [geberit.us](http://geberit.us) for latest list of code approved compatible toilet fixtures, including certified WaterSense® combinations

**Note: For System Accessories see pages 26-28.**

### Dual-Flush Actuators, Sigma 2x6 Installation

Style	Material	Finish	Model No.	List Price \$
	Plastic	Alpine White	115.770.11.5	104.00
		Polished Chrome	115.770.21.5	143.00
		Matte Chrome	115.770.JQ.5	143.00
		Brass Galvanized <b>NEW!</b>	115.770.DT.5	456.00
		Jet Black <b>NEW!</b>	115.770.DW.5	126.00
	Stainless	Brushed Nickel-Polished	115.882.ID.1	294.00
		Nickel-Brushed Nickel*		
		Brushed Stainless Steel-Polished	115.882.SN.1	295.00
		Stainless Steel-Brushed Stainless Steel*		
		Brushed Nickel-Polished Nickel-Brushed Nickel* Vandal Resistant	115.889.ID.1	343.00
	Plastic	Brushed Stainless Steel-Polished	115.889.SN.1	343.00
		Stainless Steel-Brushed Stainless Steel* Vandal Resistant		
		White Matte Coated-White <b>NEW!</b>	115.882.01.1	261.00
		White-Matte White <b>NEW!</b>	115.882.11.1	152.00
		Matte Black-Polished	115.882.14.1	261.00
		Chrome-Matte Black*		
		Black Matte Coated-Black <b>NEW!</b>	115.882.16.1	261.00
		Black-Matte Black <b>NEW!</b>	115.882.DW.1	187.00
		Matte Chrome-Polished	115.882.JQ.1	284.00
		Chrome-Matte Chrome*		
		Matte White-Polished	115.882.JT.1	261.00
		Chrome-Matte White*		
		Polished Chrome-Matte	115.882.KH.1	219.00
		Chrome-Polished Chrome*		
		White-Polished Chrome-White*	115.882.KJ.1	152.00





### Dual-Flush Actuators, Sigma 2x6 Installation (continued)

Style	Material	Finish	Model No.	List Price \$
	Plastic	White-Polished Gold-White*	115.882.KK.1	422.00
		Black-Polished Chrome-Black*	115.882.KM.1	187.00
	Zinc PVD	Customizable	115.650.00.1	724.00
		Red	115.650.JM.1	905.00
		Gold	115.650.JV.1	905.00
		Color	115.650.JX.1	1,234.00
		<b>NEW!</b>	115.650.SL.1	795.00
	Zinc PVD	Black	115.651.00.1	724.00
		Mustang Slate	115.651.JM.1	905.00
		Chrome	115.651.JV.1	905.00
		Color	115.651.JX.1	1,234.00
		<b>NEW!</b>	115.651.SL.1	795.00
Zinc PVD	Brass	Customizable	115.652.00.1	724.00
		Black	115.652.JM.1	905.00
		Chrome	115.652.JV.1	905.00
		Color	115.652.JX.1	1,234.00
		<b>NEW!</b>	115.652.SL.1	795.00
	Zinc	Camel <b>NEW!</b>	115.761.00.4	552.00
		Chrome	115.761.00.5	552.00
		Color	115.761.00.6	552.00
		<b>NEW!</b>	115.761.00.7	552.00
		<b>NEW!</b>	115.884.JV.1	552.00
		Black Walnut <b>NEW!</b>	115.884.JX.1	867.00
		Customer supplied overlay	115.884.00.1	434.00
		Lava Glass <b>NEW!</b>	115.884.JK.1	558.00
		Grey Sand Glass <b>NEW!</b>	115.884.JL.1	558.00
		Mustang Slate	115.884.JM.1	558.00
		White Glass	115.884.SL.1	558.00
		Black Glass	115.884.SJ.1	558.00
	Plastic	White Matte Coated-Coated-White <b>NEW!</b>	115.883.01.1	289.00
		White-Matte White <b>NEW!</b>	115.883.11.1	176.00
		Matte Black-Polished	115.883.14.1	289.00
		Chrome-Matte Black***		
		Black Matte Coated-Black <b>NEW!</b>	115.883.16.1	289.00
		Black-Matte Black <b>NEW!</b>	115.883.DW.1	198.00
		Matte Chrome-Polished	115.883.JQ.1	302.00
		Chrome-Matte Chrome***		
		Matte White-Polished	115.883.JT.1	289.00
		Chrome-Matte White***		
		Polished Chrome-Matte	115.883.KH.1	246.00
		Chrome-Polished Chrome***		
		White-Polished Chrome-White***	115.883.KJ.1	154.00
		White-Polished Gold-White***	115.883.KK.1	198.00
		Black-Polished Chrome-Black***	115.883.KM.1	198.00
	Zinc PVD	Customizable	115.670.00.2	724.00
		Red	115.670.11.2	724.00
		Gold	115.670.DW.2	724.00
		Color	115.670.JM.2	905.00
		<b>NEW!</b>	115.670.JV.2	905.00
	Zinc PVD	Black	115.671.00.2	724.00
		Chrome	115.671.11.2	724.00
		Color	115.671.DW.2	724.00
		<b>NEW!</b>	115.671.JM.2	905.00
		<b>NEW!</b>	115.671.JV.2	905.00
		Black Walnut	115.671.JX.2	1,234.00

**Products marked with  comply with the American Disabilities Act (ADA) when installed per the requirements of the latest ADA Accessibility Guidelines (ADAAG) and/or ICC/ANSI A117.1.**

The information contained in this document is subject to change without notice.

**Dual-Flush Actuators, Sigma 2x6 Installation** 

Style	Material	Finish	Model No.	List Price \$
	Zinc PVD Brass Color <i>NEW!</i>	Customizable	115.672.00.2	724.00
		White	115.672.11.2	724.00
		Black	115.672.DW.2	724.00
		Mustang Slate	115.672.JM.2	905.00
		Concrete Look	115.672.JV.2	905.00
	Zinc Chrome Color	Black Walnut	115.672.JX.2	1,234.00
		Concrete Look <i>NEW!</i>	115.788.JV.2	552.00
		Black Walnut <i>NEW!</i>	115.788.JX.2	867.00
		Customizable	115.788.00.2	434.00
		White	115.788.11.2	434.00
		Bright Chrome	115.788.21.2	558.00
		Black	115.788.DW.2	434.00
		Brushed Chrome	115.788.GH.2	558.00
		Lava Glass <i>NEW!</i>	115.788.JK.2	558.00
		Grey Sand Glass <i>NEW!</i>	115.788.JL.2	558.00
		Mustang Slate	115.788.JM.2	558.00
Smoked Glass	115.788.SD.2	558.00		
	Zinc Glass	Brushed Chrome	115.640.GH.1	731.00
		Lava Glass <i>NEW!</i>	115.640.JK.1	731.00
		Grey Sand Glass <i>NEW!</i>	115.640.JL.1	731.00
		White Glass	115.640.SL.1	731.00
		Black Glass	115.640.SJ.1	731.00
		Rough-in set (REQUIRED accessory)	243.168.00.1	18.00
		Cover frame (optional accessory) Polished Chrome	115.641.21.1	197.00
		Cover frame (optional accessory) Brushed Chrome	115.641.GH.1	197.00
	Plastic Stainless Glass	Customizable	115.620.00.1	619.00
		Brushed Stainless Steel	115.620.FW.1	820.00
		Lava Glass <i>NEW!</i>	115.620.JK.1	724.00
		Grey Sand Glass <i>NEW!</i>	115.620.JL.1	724.00
		White Glass	115.620.SL.1	724.00
Black Glass	115.620.SJ.1	724.00		



**Single-Flush Actuators, Sigma 2x6 Installation** 

Style	Material	Finish	Model No.	List Price \$	
	Stainless	Matte Black-Polished Chrome-Matte Black*	115.758.14.5	409.00	
		Matte White-Polished Chrome-Matte White*	115.758.JT.5	409.00	
		Brushed Stainless Steel-Polished Stainless Steel-Brushed Stainless Steel*	115.758.SN.5	299.00	
		Brushed Stainless Steel-Polished Stainless Steel-Brushed Stainless Steel* Vandal Resistant	115.787.SN.5	339.00	
		Plastic	Polished Chrome-Matte Chrome- Polished Chrome*	115.758.KH.5	219.00
			White-Polished Chrome-White*	115.758.KJ.5	153.00
			White-Polished Gold-White*	115.758.KK.5	435.00
			Black-Polished Chrome-Black*	115.758.KM.5	187.00
			Matte Chrome-Polished Chrome-Matte Chrome*	115.758.JQ.5	219.00

**Single-Flush Actuators, Sigma 2x6 Installation** 

Style	Material	Finish	Model No.	List Price \$
	Zinc	Matte Black-Polished Chrome-Matte Black***	115.893.14.1	390.00
		Matte White-Polished Chrome-Matte White***	115.893.JT.1	390.00
		Polished Gold***	115.893.45.1	3,157.00
		White-Polished Chrome-White***	115.893.KJ.1	290.00
		Brushed Chrome-Polished Chrome- Brushed Chrome***	115.893.KX.1	427.00
		Polished Chrome-Brushed Chrome- Polished Chrome***	115.893.KY.1	427.00

**Dual-Flush Hands-Free Actuators and Transformer, Sigma 2x6 Installation** 

Style	Material	Finish	Model No.	List Price \$	
	Stainless	Brushed Stainless Steel-Polished Stainless Steel-Brushed Stainless Steel* Vandal Resistant (AC Power with manual override)	115.890.SN.5	1025.00	
		Brushed Stainless Steel-Polished Stainless Steel-Brushed Stainless Steel* Vandal Resistant (Battery/DC Power with manual override)	115.891.SN.5	1056.00	
	Plastic	Polished Chrome-Matte Chrome* (AC Power)	115.907.KH.1	836.00	
		White-Polished Chrome* (AC Power)	115.907.KJ.1	836.00	
		White-Polished Gold* (AC Power)	115.907.KK.1	836.00	
		White-Matte Chrome* (AC Power)	115.907.KL.1	836.00	
		Black-Polished Chrome* (AC Power)	115.907.KM.1	836.00	
		Matte Chrome-Polished Chrome* (AC Power)	115.907.KN.1	836.00	
		Stainless	Brushed Stainless Steel-Polished Stainless Steel* (AC Power)	115.907.SN.1	897.00
			Required Transformer for AC powered hands-free actuator (order separately)	115.861.00.1	175.00
			Polished Chrome-Matte Chrome* (Battery)	115.908.KH.1	860.00
			White-Polished Chrome* (Battery)	115.908.KJ.1	860.00
	Glass	Black (AC Power)	116.090.SG.1	1,713.00	
		Mirror (AC Power)	116.090.SM.1	1,713.00	
		Note: Sigma80 not recommended for bidet seat applications			
		Required Transformer for AC powered hands-free actuator (order separately)	115.861.00.1	175.00	
		Plastic	Extension mains cable (optional accessory for Sigma10 and Sigma80) length 78-3/4" (2 m)	241.831.00.1	84.00

**Remote Programming Accessory for Hands-Free Actuators**

	"Service Handy" remote programming device for Geberit touch-free devices	115.860.00.1	411.00
---	---	--------------	--------

\* Finishes follow this pattern = Plate-Ring-Button  
 \*\* Finishes follow this pattern = Frame-Button  
 \*\*\*Finishes follow this pattern = Frame-Button Edge Trim-Button  
 † Note: For tile, stone or other hard surfaced walls only!  
 ‡ Not intended to be sold in California with 1.6 GPF units











The information contained in this document is subject to change without notice.

**Products marked with  comply with the American Disabilities Act (ADA) when installed per the requirements of the latest ADA Accessibility Guidelines (ADAAG) and/or ICC/ANSI A117.1.**



# GEBERIT INSTALLATION SYSTEMS

## Systems for Wall-Hung Toilets for Sigma 2x6 Installation

### Dual-Flush Buttons for Concealed Installations, Sigma 2x6 Installation

Style	Material	Finish	Model No.	List Price \$
Type 01 	Plastic	Alpine White	116.042.11.1	139.00
		Polished Chrome	116.042.21.1	181.00
Type 10 	Plastic	Alpine White 	116.044.11.1	139.00
		Matte Chrome-Polished Chrome**	116.055.KH.1	198.00
		Polished Chrome-White**	116.055.KJ.1	181.00
Type 70 	Stainless	Brushed Stainless Steel 	115.630.FW.1	923.00
		Lava Glass <b>NEW!</b>	115.630.JK.1	785.00
	Glass	Grey Sand Glass <b>NEW!</b>	115.630.JL.1	785.00
		White Glass 	115.630.SI.1	785.00
		Black Glass 	115.630.SJ.1	785.00
Rectangle 	Plastic	Polished Chrome-Matte Chrome**	116.051.KA.1	181.00
		Black-Chrome <b>NEW!</b>	116.051.KV.1	181.00
	Zinc	Brushed Chrome	116.051.GH.1	313.00
	Plastic	Polished Chrome 	116.052.21.1	181.00

### Dual-Flush Buttons for Furniture Installations, Sigma 2x6 Installation



Style	Material	Finish	Model No.	List Price \$
Type 01 	Plastic	Alpine White	116.050.11.1	139.00
		Polished Chrome	116.050.21.1	181.00
		Matte Chrome	116.050.46.1	181.00
Type 10 	Plastic	Matte Chrome-Polished Chrome**	116.057.KH.1	198.00
		Polished Chrome-White**	116.057.KJ.1	181.00

### Single-Flush Buttons for Concealed Installations, Sigma 2x6 Installation



Type 01† 	Plastic	Alpine White	116.040.11.1	119.00
		Polished Chrome	116.040.21.1	139.00

### Extension Hoses for Flush Button Installations

(For Flush Buttons located beyond 6' from carrier)

	Double pneumatic hose for dual-flush 78.74" (2 m) (Blue/Clear for Type01/Type10/Rectangle)	240.575.00.1	10.00
	Double pneumatic hose, 78.74" (2 m), dual-flush (Green/Clear for Type70)	243.297.00.1	10.00
	Pneumatic hose 137.80" (3.5 m) for single flush	256.000.00.1	9.00

### Cover Plates for Sigma Concealed Tank, Sigma 2x6 Installation, for use with Flush Buttons

	Glass	White	115.766.SI.1	243.00	
		Stainless	Brushed Stainless Steel	115.764.FW.1	194.00
			Vandal Resistant	115.766.00.1	194.00
	Plastic	Alpine White	115.768.11.1	85.00	
		Polished Chrome	115.768.21.1	111.00	
		Matte Chrome	115.768.46.1	111.00	

### Surface Even Cover Plates for Sigma Concealed Tank, 2x6 Installation, for use with Flush Buttons

	Plastic	Customizable†	115.696.00.1	243.00
		Customizable with frame†	115.697.00.1	306.00
		Rough-in set (REQUIRED accessory. Purchase with one of above)	243.168.00.1	18.00

\* Finishes follow this pattern = Plate-Ring-Button

\*\* Finishes follow this pattern = Frame-Button

\*\*\*Finishes follow this pattern = Frame-Button Edge Trim-Button

† Note: For tile, stone or other hard surfaced walls only!

‡ Not intended to be sold in California with 1.6 GPF units

The information contained in this document is subject to change without notice.

# GEBERIT INSTALLATION SYSTEMS

## Replacement Parts

### Geberit Duofix Carrier 111.335.00.5 and 111.902.00.5, Sigma 2x6 Installation

Item	Model No.	Description	List Price \$
1	242.314.00.1	Materials for Concealed Carrier and Tank installation	66.00
2	242.315.00.1	Splash guard protection cover for Sigma Concealed Tank	10.00
3	243.345.00.1 or 243.168.00.1	Mud guard protection housing for Sigma Concealed Tanks 2x6 and 2x4, plastic	18.00
4	362.771.00.1	Seal for concealed flush pipe, EPDM	4.00
5	362.796.92.1	Protection plug, plastic	7.00
6	240.189.00.1	Threaded rod for wall-mounted toilet or bidet installation	6.00
7	152.404.46.1	Connector set with mounting hardware (bowl installation kit), HDPE; Matte Chrome cover caps	50.00
7	152.404.11.1	Connector set with mounting hardware (bowl installation kit), HDPE; Matte White cover caps (accessory only)	50.00
7.1	217.713.46.1	Cover caps with leveling washer, plastic, Matte Chrome	8.00
7.2	119.668.00.1	Seal for supply inlet tube, EPDM	4.00
7.3	152.424.00.1	Seal for toilet outlet connector, EPDM	6.00
8	366.061.16.1	HDPE waste fitting outlet bend, 1 x 90° bend with socket for Ø3.50" (Ø90 mm) push fit piping and Ø3.50" (Ø90 mm) outlet	25.00
8.1	387.282.00.1	Seal for outlet bends, EPDM	6.00
9	366.820.92.1	Protection plug, plastic	5.00
10	—	Flexible coupling FERNCO 3005-33	—
11	242.012.00.1	Outlet pipe bracket (complete)	7.00

Item	Model No.	Description	List Price \$
12	242.886.00.1	Conduit pipe for shower toilet water supply with Sigma Concealed Tank 2x6, Omega Concealed Tank or Kappa Concealed Tank (from 2013 on)	14.00
13	111.892.00.1	Frame mounting screws for steel stud construction, galvanized, self-tapping	7.00
14	240.853.00.1	Supply angle stop (black handle)	15.00
14.1	240.851.00.1	Drop ear elbow, copper	15.00
15	240.921.00.1	Connection hose for Sigma Concealed Tank, 3/8"	17.00
15.1	240.922.00.1	Set of seals for RFB hose	5.00
16	240.923.00.1	Fixation clip for filling valve	7.00
17	241.469.00.1	Filling valve Type 380 for Sigma, Omega and Kappa Concealed Tanks	32.00
17.1	240.771.00.1	Seal kit for filling valve Type 380	12.00
18.1	241.167.00.1	Yoke set for flush valves	12.00
18.2	816.418.00.1	Geberit flat gasket for flush valve	4.00
19.1	241.868.00.1	U-cup seal for valve basket	4.00
20	241.829.00.1	Flush actuator gear box	10.00
21	240.269.00.1	Angle stop valve to concealed tank (blue handle)	23.00
21.1	240.298.00.1	Spindle to angle stop valve	18.00
21.2	241.857.00.1	Counter nut, plastic	6.00
21.3	240.347.00.1	Handle for angle stop valve (blue)	6.00
22	244.125.00.1	Foot plate set	17.00
23	242.698.00.1	Concealed Flush Bend for Sigma tank	38.00
24A	245.380.00.1	1.6/0.8 GPF dual flush valve for Sigma Tanks	23.00
24B	245.400.00.1	1.28/0.8 GPF dual flush valve for Sigma Tanks	23.00
24.1	244.844.00.1	Handle set	14.00
24.2	244.244.00.1	Flat gasket seal	4.00
24.3	241.868.00.1	U-cup seal for valve basket	4.00

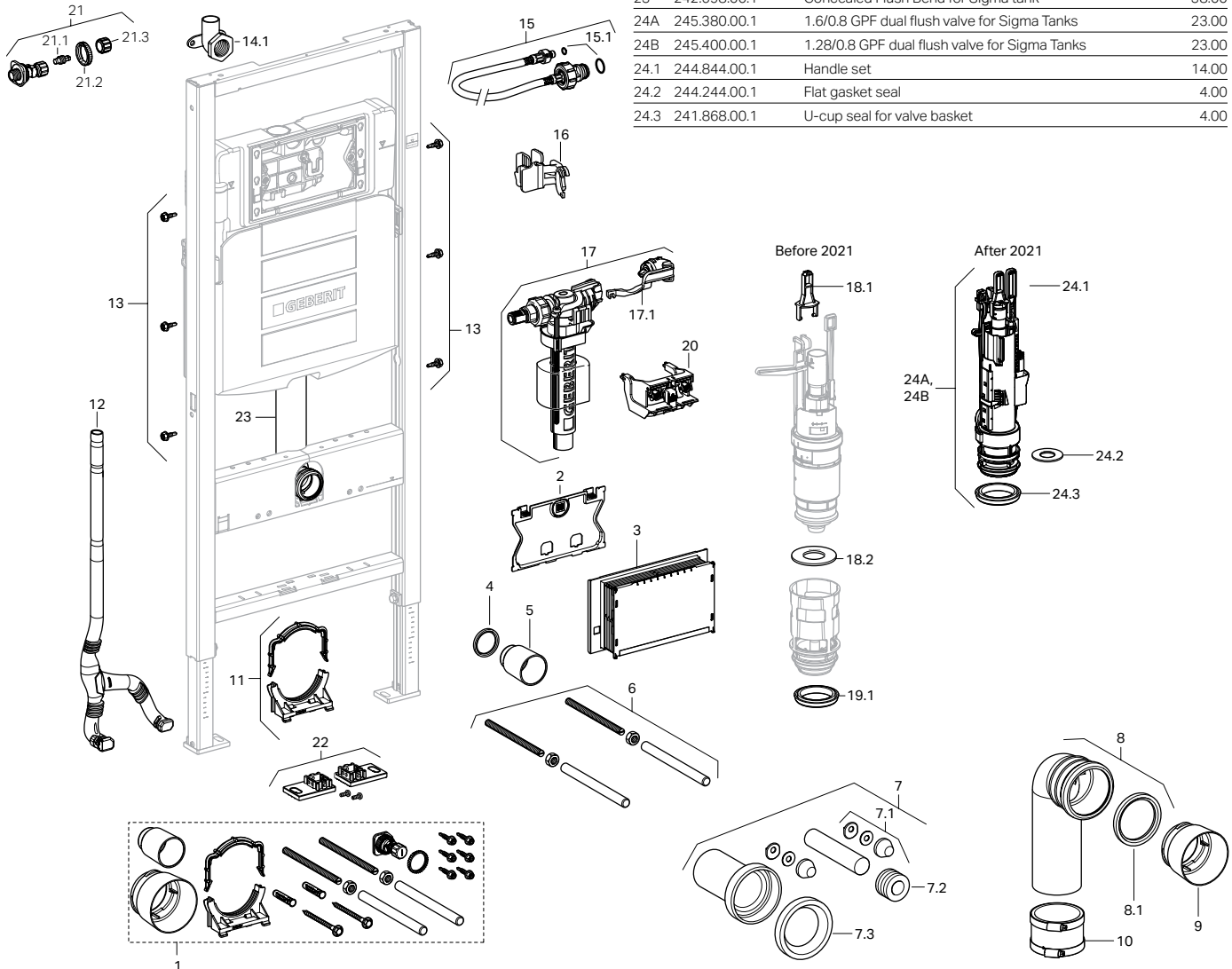

The information contained in this document is subject to change without notice.



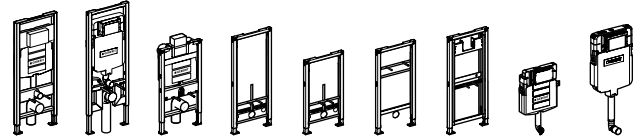

# GEBERIT SYSTEM ACCESSORIES

## Geberit Optional and Required Accessories for Installation



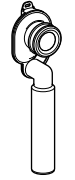

Description	Model Number	List Price \$	111.335	111.798	111.012						109.304		
			111.902	111.597	111.018	111.520	111.524	111.490	111.625	109.307	109.797		

### OPTIONAL Connection Sets and Accessories for Finished Walls up to 3.5" (9cm) Thick

	PE syphon trap with horizontal outlet and seal; Ø1.96" (Ø50 mm) outlet	152.950.11.1	40.00										✓		
	PE syphon trap with vertical outlet and seal; Ø1.97" (Ø50 mm) outlet	152.951.11.1	40.00										✓		
	Acoustic insulation set for wall-hung toilets and bidets	156.050.00.1	21.00	✓	✓	✓	✓	✓							
	Cover caps with leveling washer, plastic, Alpine White	217.713.11.1	10.00	✓	✓	✓	✓	✓	✓						
	HDPE connection set with 1" (2.5 cm) offset and mounting hardware (bowl installation kit); with socket for Ø3.50" (Ø90 mm) push fit piping and Ø55 supply inlet; Matte Chrome cover caps	405.116.00.1	252.00	✓	✓	✓								✓	✓

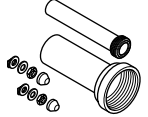
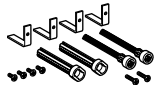
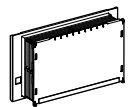
### REQUIRED Connection Sets and Accessories for Finished Walls 3.5" - 7.0" (9-18cm) Thick

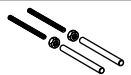
	HDPE Connector set for extended installation and mounting hardware (bowl installation kit), with socket for Ø3.50" (Ø90 mm) push fit piping and Ø2.16" (Ø55 mm) supply inlet; Matte Chrome cover caps	152.438.46.1	63.00	✓	✓	✓								✓	✓
	Extension set for actuator plates for Sigma Concealed Tanks 2x6 and 2x4, Kappa and Omega Concealed Tanks	240.938.00.1	28.00	✓	✓	✓								✓	✓
	Mud guard protection housing for Sigma Concealed Tanks 2x6 and 2x4, plastic, 4 inch (10 cm)	241.826.00.1	15.00	✓	✓									✓	✓
	Mud guard protection housing and extension set for urinal carrier	241.930.00.1	22.00										✓		
	Mounting rod M12 x 10" long. Not supplied.	M12 x 10"	—	✓	✓	✓	✓	✓							
	Mounting rod M10 x 10" long. Not supplied.	M10 x 10"	—							✓					
	Mounting rod M8 x 10" long. Not supplied.	M8 x 10"	—									✓			

The information contained in this document is subject to change without notice.

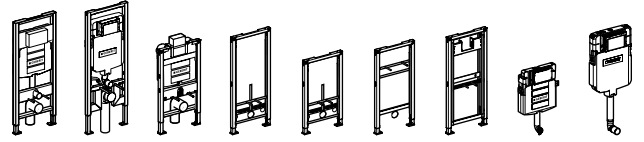

Description	Model Number	List Price \$	111.335	111.798	111.012						109.304
			111.902	111.597	111.018	111.520	111.524	111.490	111.625	109.307	109.797

**OPTIONAL Installation Accessories for Bidet Seats**

	Water supply hose for bidet seat for Kappa and Omega Concealed Tank pre-wall. For adding bidet seat to an installed carrier. For complete installation, must order with 249.801.00.1.	240.839.00.1	72.00			✓							
	Water supply hose for bidet seat for 111.597.00.1 and 111.798.00.1 carrier with Sigma Concealed Tank 2x4. For adding bidet seat to an installed carrier. For complete installation, must order with 249.801.00.1.	243.173.00.1	54.00		✓								
	Water supply hose for bidet seat add-on after finished installation of Sigma 2x6 and 2x4, Kappa and Omega Concealed Tanks.	249.801.00.1	130.00	✓	✓	✓							

**OPTIONAL Installation Accessories for Geberit Duofix Carrier Frames**

	Frame to wall anchoring for 5.125"-7.875" (13-20 cm) thick unfinished pre-wall	111.013.00.1	27.00		✓								
	Frame to wall anchoring for 5.125"-7.875" (13-20 cm) thick unfinished pre-wall	111.815.00.1	39.00	✓		✓	✓	✓	✓	✓			
	Frame to wall anchoring for 5.125"-7.875" (13-20 cm) thick unfinished pre-wall corner installations	111.835.00.1	39.00	✓	✓	✓	✓	✓	✓	✓			
	Support brackets for wall-hung toilets with small contact surface (thin profiles)	111.847.00.1	54.00	✓		✓							
	Fire protection set for Sigma Concealed Tank 90 min. fire resistance to DIN EN 1364-1:1999-10	111.863.00.1	586.00	✓									
	Frame to wall anchoring where foot installations into floor are not allowed for 5.125"-9.50" (13-24 cm)	111.064.00.1	74.00	✓	✓	✓	✓	✓	✓	✓			
	Fastening set for sinks with 14.9"-22.8" (38-58 cm) mounting centers	111.868.00.1	128.00							✓			
	Frame to stud fastening set for extended stud spacing from 19.75"-25.56" (50-65 cm)	111.869.00.1	39.00	✓	✓	✓	✓	✓	✓	✓			
	Frame to wall anchoring extensions for 7.875"-15.75" (20-40 cm) thick (unfinished pre-wall)	111.887.00.1	17.00	✓	✓	✓	✓	✓	✓	✓			
	Crossbar for inlet 1/2" thread	242.042.00.1	121.00								✓		
	Retrofit adapter for inlet, 1/2" thread	242.309.00.1	121.00								✓		
	Elbow supply fitting set, Gun Metal	465.034.00.2	42.00				✓	✓	✓				

The information contained in this document is subject to change without notice.

# GEBERIT SYSTEM ACCESSORIES

## Geberit Optional and Required Accessories for Installation

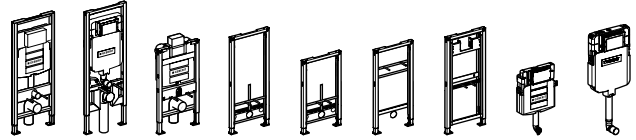

Description	Model Number	List Price \$	List								109.304	
			111.335	111.798	111.012	111.520	111.524	111.490	111.625	109.307	109.797	

### OPTIONAL Installation Waste Fitting Accessories

Description	Model Number	List Price \$	111.335	111.798	111.012	111.520	111.524	111.490	111.625	109.307	109.797
PP connector set with bend for floor-mount toilets with mounting hardware, 1 x 90° bends with socket for Ø4.375" (Ø110 mm) push fit piping for Ø3.82"-4.21" (Ø97-107 mm) male connection and expansion to Ø4.375" (Ø110 mm) outlet	152.647.00.1	128.00								✓ (For A or B discharge. See below)	✓
HDPE waste fitting outlet bend, 1 x 90° bend with socket for Ø3.50" (Ø90 mm) push fit piping and Ø3.50" (Ø90 mm) outlet	366.061.16.1	25.00								✓ (For A discharge. See below)	✓
HDPE straight connector with socket for Ø3.50" (Ø90 mm) push fit piping and Ø3.50" (Ø90 mm) outlet x 12" (31 cm) long	366.887.16.1	39.00	✓	✓	✓					✓ (For A discharge. See below)	✓
HDPE connector with offset for LH horizontal drain connections (as viewed from sitting position), 1 x 90° bend with socket for Ø3.50" (Ø90 mm) push fit piping, with 45° offset and Ø3.50" (Ø90 mm) outlet for 5.5" (13.97 cm) minimum walls only.	366.913.16.1	83.00	✓	✓	✓					✓ (For A discharge. See below)	✓
HDPE connector with offset for RH horizontal drain connections (as viewed from sitting position), 1 x 90° bend with socket for Ø3.50" (Ø90 mm) push fit piping, with 45° offset and Ø3.50" (Ø90 mm) outlet for 5.5" (13.97 cm) minimum walls only.	366.914.16.1	83.00	✓	✓	✓					✓ (For A discharge. See below)	✓
Cast iron fitting; 90° 3.5" (90 mm) inlet, 3" outlet, 2" NPTF heel outlet	367.072.18.1	251.00	✓	✓	✓					✓ (For A discharge. See below)	✓
HDPE "Back-to-back" connector for horizontal drain connections; 2 x 90° bends with sockets for Ø3.50" (Ø90 mm) push fit piping, with 45° offset and expansion to Ø4.375" (Ø110 mm) outlet for 10.75" (27.31 cm) minimum walls only.	367.485.16.1	170.00	✓	✓	✓					✓ (For A or B discharge. See below)	✓
HDPE "Back-to-back" connector for vertical drain connections; 2 x 90° bends with sockets for Ø3.50" (Ø90 mm) push fit piping and expansion to Ø4.375" (Ø110 mm) outlet for 10.75" (27.31 cm) minimum walls only.	367.923.16.1	166.00	✓	✓	✓					✓ (For A or B discharge. See below)	✓

Note: Any of these fittings in combination with Geberit installation systems are cUPC and IPC listed.

### Waste Fitting Discharge Configurations for Floor Mount Back Outlet Toilets

Note: Mounting collar/clamp by installer

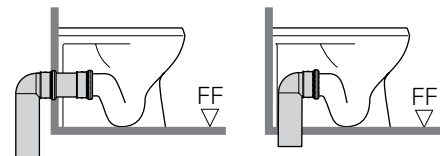

**A. Floor-Mount Rear Discharge into Wall**

**B. Floor-Mount Rear Discharge into Floor**

The information contained in this document is subject to change without notice.